

BAT-640

(6V4.0Ah)



WA series is a general purpose battery with 5 years design life in float service . It meets with IEC and JIS standards . With up-dated AGM valve regulated technology and high purity raw materials, the WA series battery has reliable standby service life. It is suitable for UPS/EPS, medical equipment, emergency light and security systems applications.

Specifications

Nominal Voltage		6V
Rated capacity (20 hour rate)		4Ah
Dimensions	Length	70±1mm(2.76inch)
	Width	48±1mm(1.89inch)
	Height	101±1mm(3.98inch)
	Total Height	107±1mm(4.21inch)
Approx. Weight		0.68kg(1.52lbs)±5%

Outer dimensions (mm)

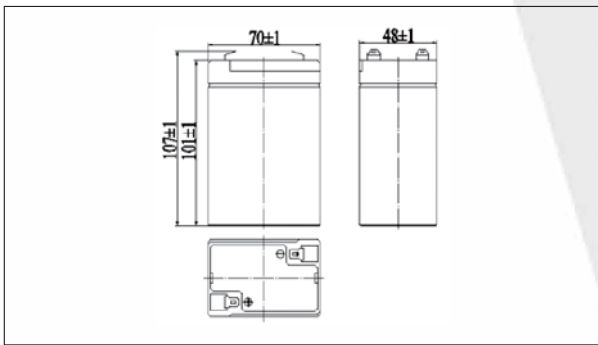

Terminal Type (mm)

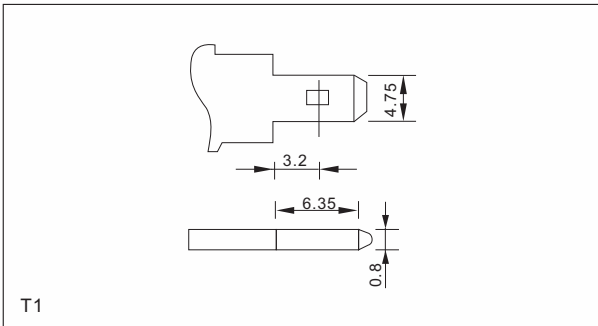

Construction

Component	Positive plate	Negative plate	Container	Cover	Separator	Electrolyte	Safety valve	Terminal
Raw material	Lead dioxide	Lead	ABS	ABS	AGM	Sulfuric acid	Rubber	Copper

Constant Current Discharge Characteristics Unit:A(25°C,77°F)

F.V/Time	5min	10min	15min	30min	60min	2h	3h	4h	5h	10h	20h
4.80V	15.3	9.68	7.56	4.26	2.62	1.43	0.99	0.82	0.78	0.38	0.20
4.95V	14.8	9.39	7.38	4.17	2.58	1.42	0.99	0.82	0.69	0.38	0.20
5.10V	14.2	9.00	7.11	4.05	2.52	1.41	0.98	0.81	0.69	0.38	0.20
5.25V	13.6	8.62	6.86	3.95	2.47	1.39	0.97	0.80	0.68	0.37	0.20
5.40V	12.8	8.13	6.50	3.80	2.39	1.36	0.94	0.78	0.66	0.37	0.20

Constant Power Discharge Characteristics Unit:W(25°C,77°F)

F.V/Time	5min	10min	15min	30min	60min	2h	3h	4h	5h	10h	20h
4.80V	85.3	54.6	43.1	24.4	15.2	8.38	5.89	4.88	4.17	2.27	1.22
4.95V	82.7	53.0	42.1	23.9	14.9	8.33	5.85	4.85	4.14	2.26	1.21
5.10V	79.3	50.8	40.5	23.2	14.6	8.26	5.81	4.82	4.11	2.25	1.21
5.25V	75.9	48.6	39.1	22.6	14.3	8.14	5.77	4.79	4.08	2.24	1.20
5.40V	71.6	45.9	37.1	21.8	13.8	7.93	5.60	4.64	3.96	2.19	1.18

Note: The above characteristics data can be obtained within three charge or discharge cycles.

Characteristics

Capacity (25°C)	20HR(3.50V)	4Ah
	10HR(3.50V)	3.7Ah
	1HR(3.20V)	2.4Ah
Terminal type		T1
Internal resistance (Fully charged,25°C)		Approx.30m Ω
Capacity affected by temperature (20HR)	40°C	102%
	25°C	100%
	0°C	85%
	-15°C	65%
Self-discharge (25°C)	3 months	Remaining Capacity:91%
	6 months	Remaining Capacity:82%
	12 months	Remaining Capacity:65%
Nominal operating temperature		25°C ±3°C(77°F ±5°F)
Operating temperature range	Discharge	-15°C~50°C(5°F~122°F)
	Charge	-10°C~50°C(14°F~122°F)
	Storage	-20°C~50°C(-4°F~122°F)
Float charging voltage(25°C)		6.75 to 6.90V Temperature compensation: -9mV/°C
Cyclic charging voltage(25°C)		7.25 to 7.50V Temperature compensation: -15mV/°C
Maximum charging current		1.2A
Maximum discharge current		60A(5 sec.)
Designed floating life(20°C)		5 years

BAT-640

(6V4.0Ah)



Discharge characteristics(25°C)

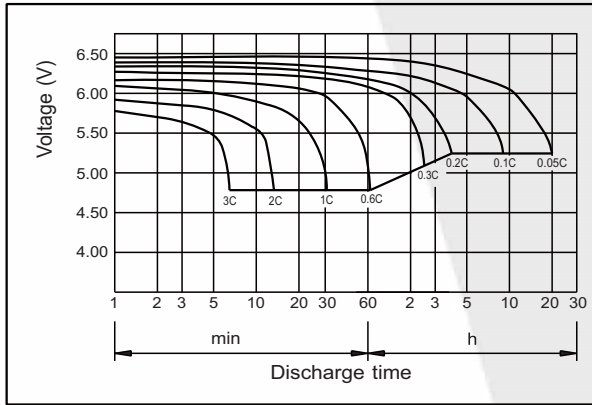

Charging characteristics (25°C)

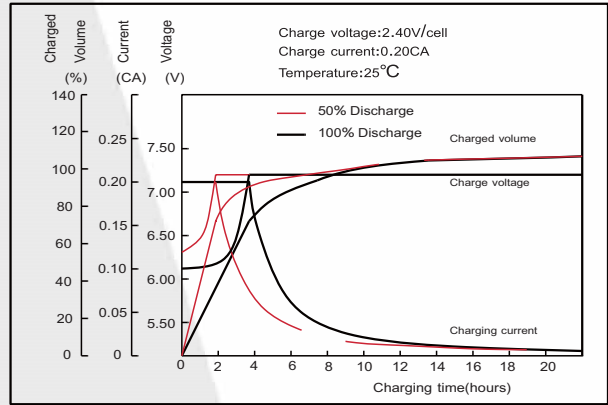

Effect of temperature on capacity

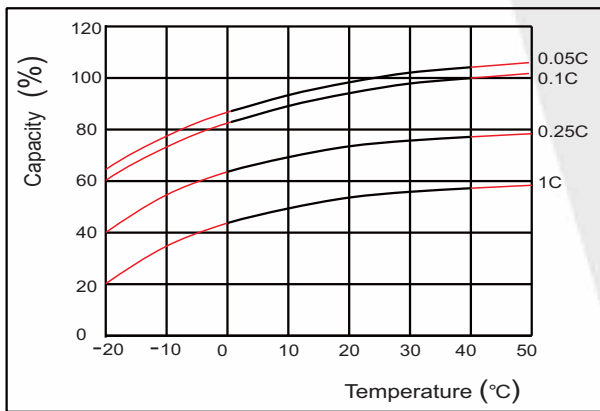

Self-discharge characteristics

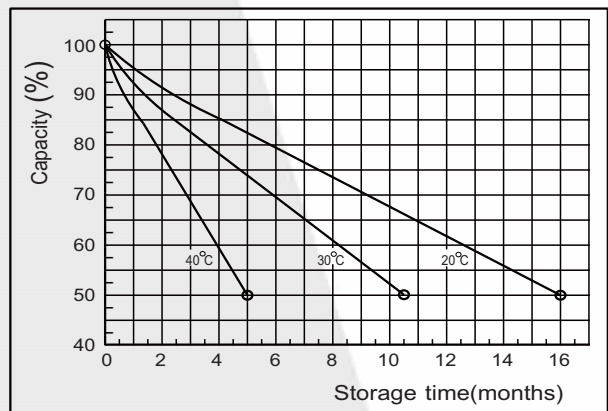

Floating life on temperature

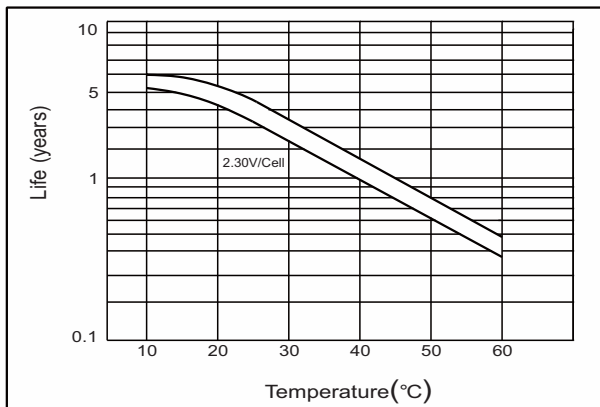

Cycle life on D.O.D(25°C)

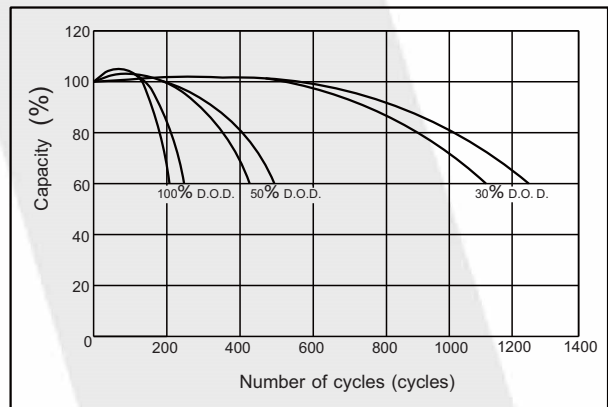

The relationship for OCV and Capacity (25°C)

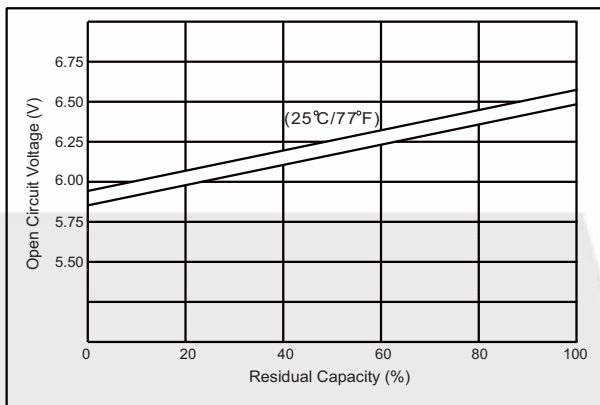

The relationship for Charging voltage and Temperature

